

Track Roller

21T-30-00211



Main specification parameter for Track Roller

Brand	Model	Product Name	Part Number
Komatsu	PC2000-8	Track Roller	21T-30-00211



Compatible Equipment Models: PC2000-8

We are committed to providing a variety of parts including bulldozers, excavators and wheel loaders for well-known brands such as Carter and Komatsu. Our product line covers a full range of OEM parts, such as Track Chain, Track Rollers, Sprocket, Excavator Buckets, Blades, Excavator Cylinders, Swing Circles, and various electrical and hydraulic components to ensure that our customers' stringent requirements for quality and performance are met.



Stone (Shanghai) Engineering Machinery Co., Ltd. is a leading supplier of engineering machinery parts, focusing on providing high-quality parts for mining companies. Since its establishment in 2004, we have been based in Shanghai, China, and have built our own brand STONE, becoming a trusted choice in the industry.

Product Detail

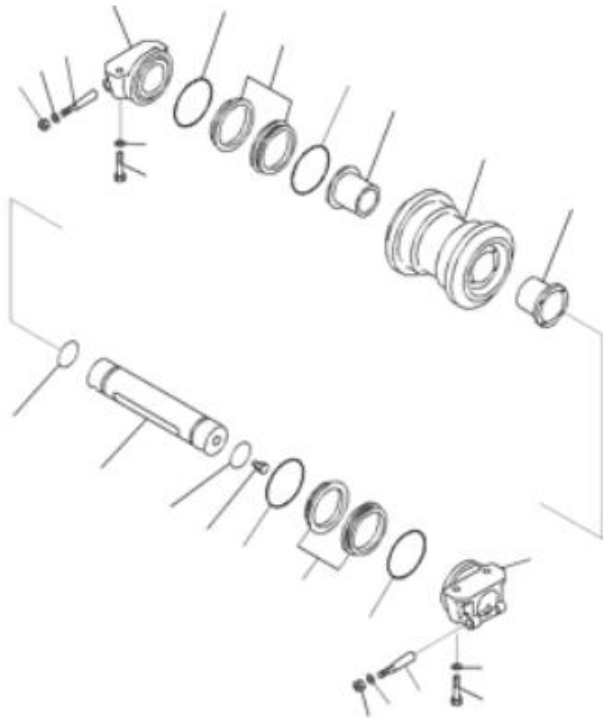

Product Name	Track Roller
Part Number	21T-30-00211
Origin	Japan
Brand Name	STONE
Model	PC2000-8
Price	Negotiable
Packing Details	Standard Export Packing
Delivery Time	0-30 Days
Payment Term	L/C, T/T
Price Term	FOB, CIF, CFR
Supply Capacity	50,000 PCS/Month
Minimum Order Quantity	1 PC
Material	High Quality Steel
Technology	Precision Machining
Surface	Treatment Anti-Corrosion Coating
Hardness	HRC 48-52
Quality	Original Factory Standard
After-Sales Service	Full Support, Online Service
Color	Customizable
Application	Excavator
Customizable	including customized materials, surface treatment and specifications



STONE

STONE Product Case Brochure

E-mail:sale@shmpine.com

Tel:+8613671661119(Wechat/WhatsApp)

Address:No. 348 Huajiang Road, Room 221, Shenyao Art Center, Jiading District, Shanghai



About Us

STONE is a professional company focusing on mining equipment parts, providing customers with one-stop solutions for mining parts including R&D, supply and technical services. Our company has its own brand STONE and has established a professional R&D and service team of more than 30 people. Our core team has been deeply involved in the construction machinery industry for more than 20 years.

At STONE, we are committed to our mission:
Building The World Together!

Forward Design

We implement forward design and establish strict standards for raw materials, key components and process technology.

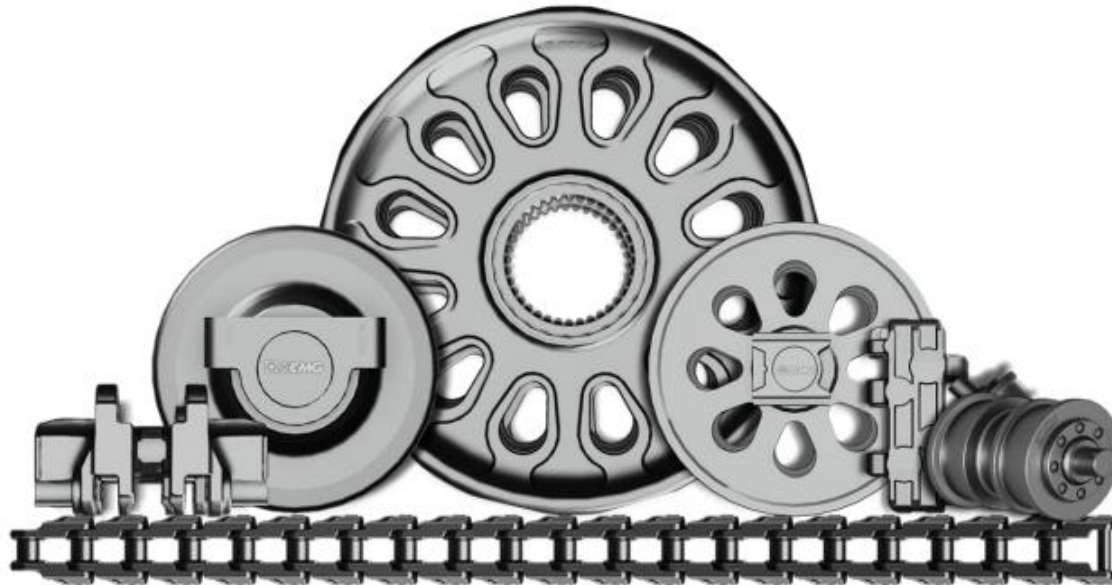

All series, All working conditions, All weather . Large-tonnage, Complete-set, Tailor-made

1000⁺ CRAWLER ASSEMBLY

We jointly develop special steel with well-known steel mills combined with induction quenching of the chain link tread and the inside and outside of pin bush, which significantly improve product wear resistance and adaptability to working conditions.



single rib plate crawler

double rib plate crawler

three rib plate crawler



cast plate crawler

whole crawler A

whole crawler B



wetland crawler

rubber plate crawler

more products



All series, All working conditions, All weather . Large-tonnage, Complete-set, Tailor-made

500 + TRACK ROLLER

The wheel body that has undergone overall hardening treatment and the floating seal verified by limit tests ensure the reliability of products under harsh working conditions such as mining and heavy loads.

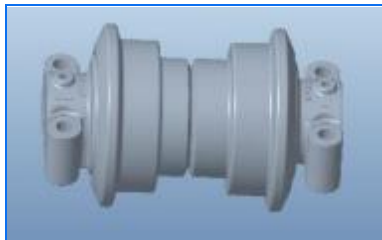

Type A

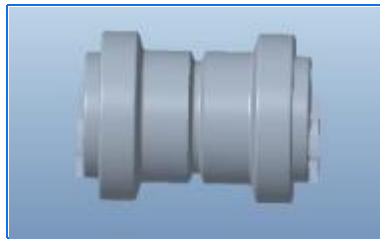

Type B

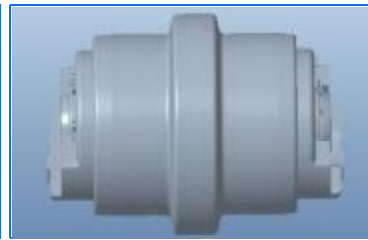

Type C

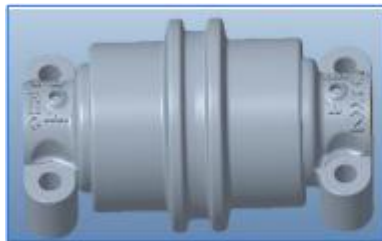

Type D

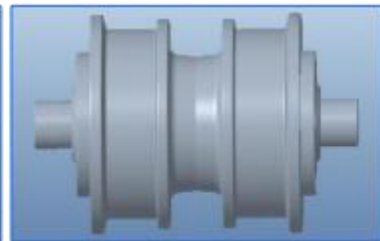

Type E



More products

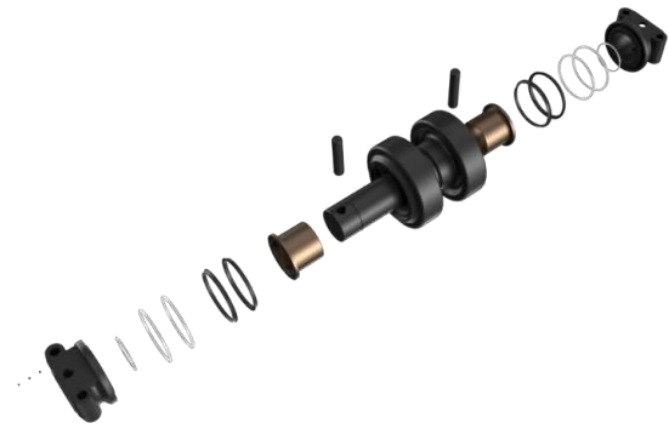

All series, All working conditions, All weather . Large-tonnage, Complete-set, Tailor-made

200 + CARRIER ROLLER

By applying anti-jamming and anti-loosening technology, advanced heat treatment technology, and a circulating structure of lubricating medium on the inner wall of the bearing, the service life of the carrier roller is greatly extended.

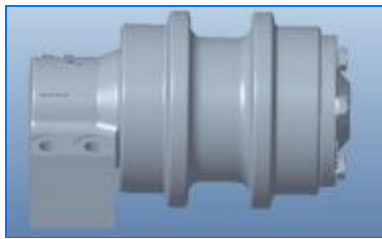

Type A

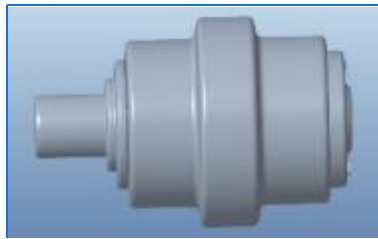

Type B

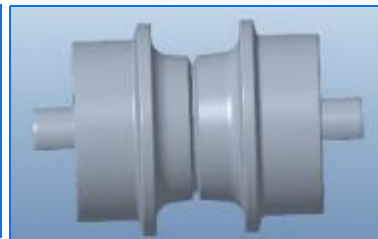

Type C



Type D

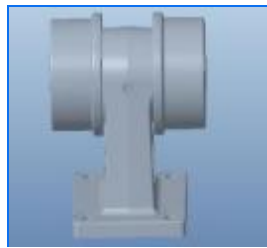

Type E

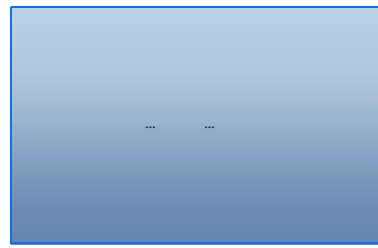

More products

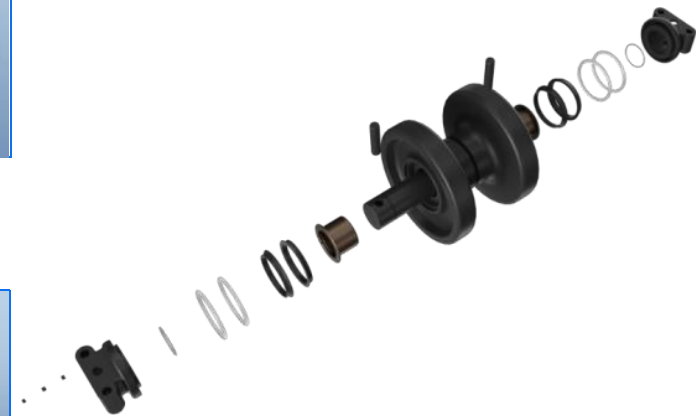

All series, All working conditions, All weather . Large-tonnage, Complete-set, Tailor-made

360 + IDLER

The wheel body is cast or forged as a whole, to have good fatigue resistance. At the same time, high-strength sliding bearings and sealing technology are used to improve the adaptability of products under extreme working conditions.



Type A

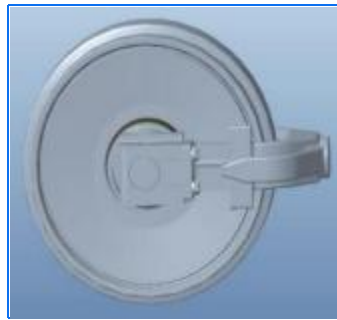

Type B



Type C

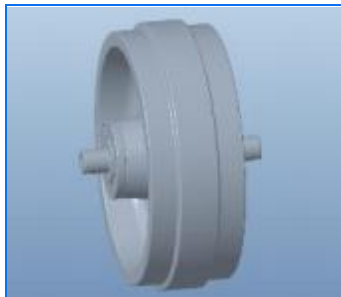

Type D



Type E

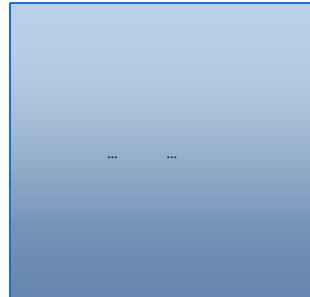

More products

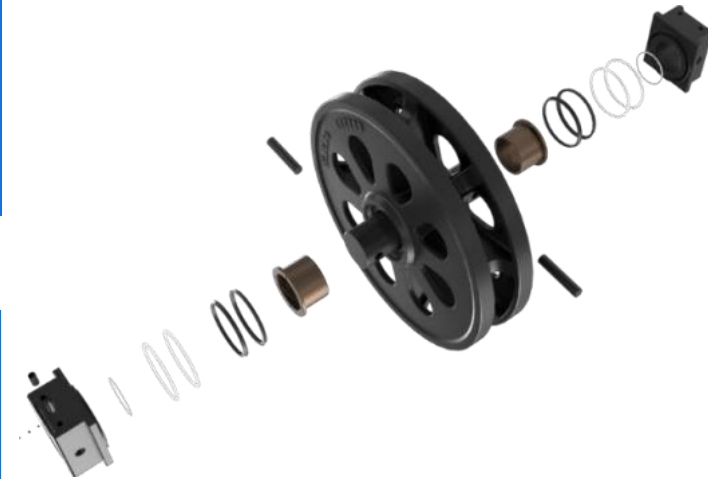

All series, All working conditions, All weather . Large-tonnage, Complete-set, Tailor-made

400 + SPROCKET

Based on the host operating conditions, design conventional teeth, continuous teeth, staggered teeth and other driving structures, we develop high alloy structural materials and heat treatment processes, achieve high-temperature reinforcement and low-temperature toughening, significantly improve product strength and wear resistance.



Type A



Type B



Type C



Type D



Type E

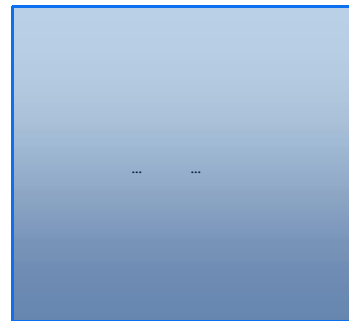

More products



All series, All working conditions, All weather . Large-tonnage, Complete-set, Tailor-made

Brand model Machines

CAT HEX

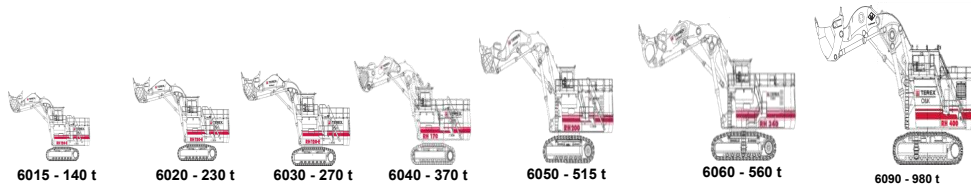

KOMATSU HEX



HITACHI HEX

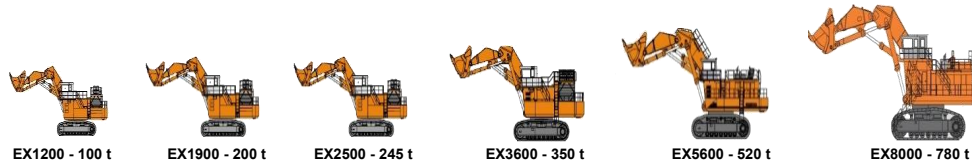

LIEBHERR HEX

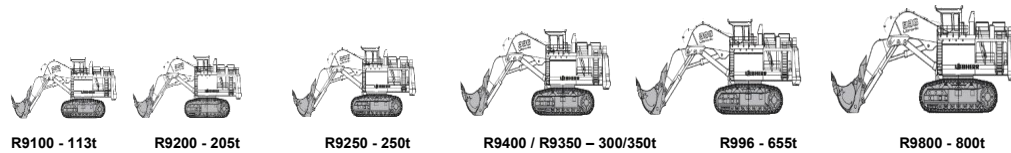

XCMG HEX



Brand model Machines

CAT bulldozer



D8/d8N/D8R



D9/D9N/D9R



D10/D10R/D10T



D11/D11N/D11R/D11T...

Construction Class	< 100 Tonne
Mining Class	> 100 Tonne
Plate Lip	< 350 Tonne
Cast Lip	> 350 Tonne

KOMATSU bulldozer



D275



D355



D375



D475

SHANTUI bulldozer



SD32



DH46



SD60



SD90

More Brand... ..
More Models... ..





CATERPILLAR®

CAT Machines

6015 / 6020 / 6030 / 6040 / 6050 / 6090

Experience

Our products have been widely used in crawler machines, such as mining machinery, earthmoving machinery, piling machinery, pavement construction machinery, lifting machinery, and we have accumulated extensive market verification experience.



CAT Machines

6015 / 6020 / 6030 / 6040 / 6050 / 6090



CAT Machines

6015 / 6020 / 6030 / 6040 / 6050 / 6090

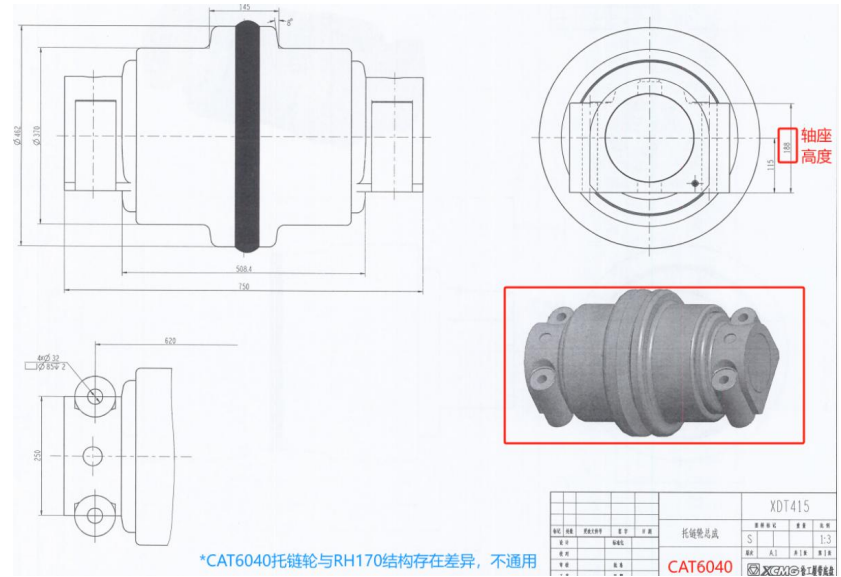

CAT Machines

D8R / D9R / D10N / D11...



CAT Machines

D8R / D9R / D10N / D11...





KOMATSU

Komatsu Machines

PC1250 / PC2000 / PC3000 / PC4000 / PC5500 / PC7000 / PC8000

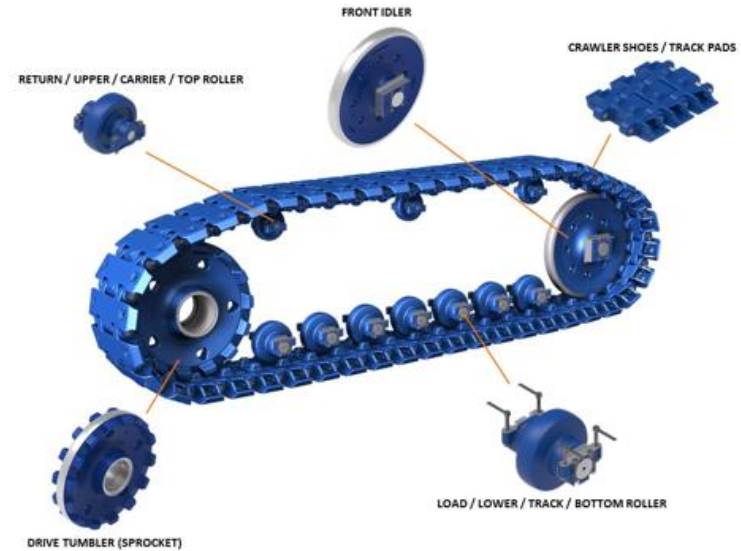

Accelerate Technology Iteration.

We apply a digital collaborative design and simulation analysis platform to analyze the load of the whole machine and provide customers with highly reliable products based on the applicable working conditions.

Komatsu Machines

PC1250 / PC2000 / PC3000 / PC4000 / PC5500 / PC7000 / PC8000



Komatsu Machines

PC1250 / PC2000 / PC3000 / PC4000 / PC5500 / PC7000 / PC8000

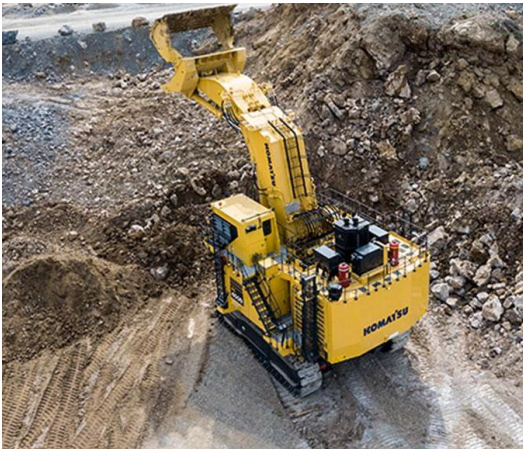

Komatsu Machines

D155 / D275 / D355/ D375 / D475





HITACHI

Hitachi Machines

EX1200 / EX1900 / EX2500 / EX3600 / EX5600 / EX8000



Hitachi Machines

EX1200 / EX1900 / EX2500 / EX3600 / EX5600 / EX8000

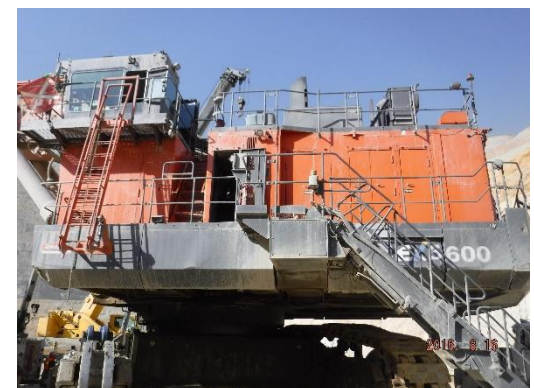

Liebherr Machines

R9100 / R9200 / R9250 / R9400 / R9800 / R966



XCMG Machines

XE1250 / XE1350 / XE2000 / XE4000 / XE5000 / XE7000

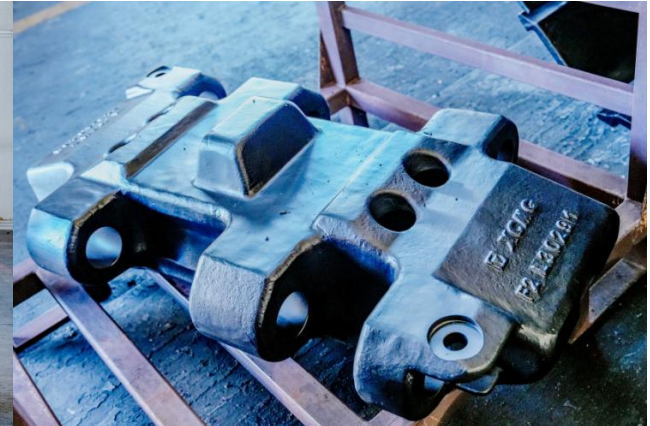

SHANTUI Machines

SD32 / DH46 / SD60 / SD90





Building the World Together!

E-mail: sale@shmpine.com

Tel: +8613671661119 (Wechat/WhatsApp)

Address: Room JT18489, Building 4, Block B, No. 925 Yecheng Road, Jiading Industrial Zone, Shanghai